

GLITI H2750 INCLUSIVE

Code: 01-MO-364

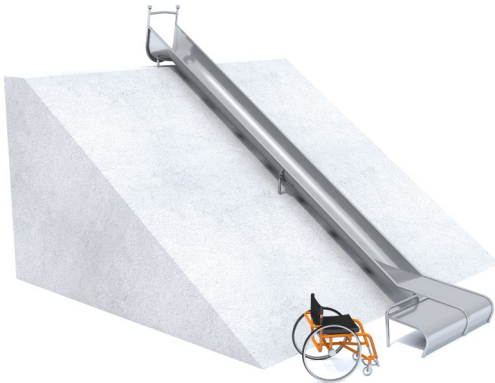

Physical



Social-emotional



Sliding down



Integration



Socialisation

Description

The **GLITI H2750 INCLUSIVE** embankment slide is a unique playground element designed with wheelchair users in mind. Thanks to its specially contoured structure, it enables all children — regardless of their abilities — to play together. At the bottom of the slide, there is a comfortable seat that allows a child to move independently after finishing the slide and to leave the sliding area safely and comfortably. Made from durable, weather-resistant materials, it guarantees safety and long-lasting use.

The **GLITI H2750 INCLUSIVE** embankment slide consists of a straight, trough-shaped slide ending with a seat for people with disabilities, allowing them to safely and independently reposition themselves after sliding. The structure is supported by eight foundation legs made of stainless steel, ensuring high strength, weather resistance, and the overall stability and durability of the equipment. The slide is made entirely of stainless steel AISI 304 (1.4301), with a sheet thickness of 2 mm and a profile of 33.7 x 2 mm; the surface is polished, corrosion-resistant, and easy to clean.

Playground device consists of

- 1 straight slide
- 1 seat for people with disabilities
- 8 foundation legs

Product details

- Dimensions (L×W×H): 5,43 x 1,45 x 3,63 m
- Safety area (L×W): 8,93 x 3,6 m
- Maximum fall height: 0,34 m
- Embankment height (L1): 2350-2750 mm
- Embankment length (L2): 4918 mm
- Embankment width (L3): 4077 mm
- Age: 3+
- Number of users: 2
- Differences in dimensions no more than +/- 5% are acceptable

Materials

- Polished slide made entirely of stainless steel AISI 304 (1.4301) with a sheet thickness of 2 mm and a profile of 33.7 × 2 mm
- Foundation legs made of stainless steel

All images are for illustrative purposes only and may vary from the actual product.

